



Global Quality Benchmark



DOUBLE-WALL
DRAWER SYSTEMS

DRAGON-PRO

DRAGON-PRO

The Metal Straight-sided Slim Drawer

A Perfect Mix of Function and Fashion



- The highly stable drawer construction ensures stable and smooth motion with soft closing for wide and high drawers.
- 13mm straight drawer side - a trendy, beautiful appearance, and much more storage space



Quietness



Intelligence



Durability



Eco-Friendliness

DRAGON-PRO

HB00 Series Straight-sided Drawer System (Low Drawer: N Height)

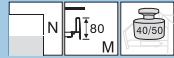

PRODUCT



DESCRIPTION

- Concealed, full extension
- Dynamic load capacity: 40/50kg
- Tool free assembly and removal of drawer
- Silent system guarantees smooth run without noise
- Up&down adjustment, left&right adjustment
- Finish: Silk white(E29), Grey matt(E30), stainless steel(F04)

SPACE REQUIREMENT

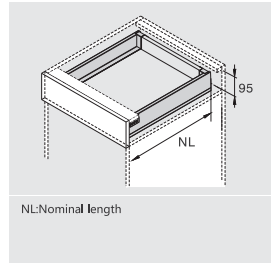

PLANNING

Installation Dimensions(mm)

NL=Nominal Slide Length
LT=Internal Cabinet Depth
LT=NL+3

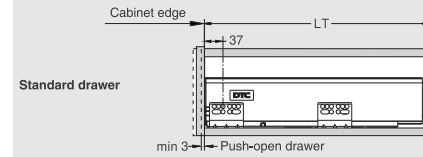

Cabinet width KB(mm)	Soft close drawer Stabilizer	Push-open drawer Synchronization rod	
300	—	○	not recommended
350	—	○	
400	—	○	
450	—	○	
500	—	○	
600	—	○	recommended
800	○	●	
900	○	●	strongly recommended
1000	○	●	
1200	○	●	

LOWER DRAWER FOR WOOD DRAWER BACK

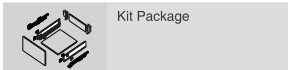

Silk White(E29) Grey Matt(E30) Stainless Steel(F04)

NL	Soft Close Item No.	Push-open Item No.	Set/ctn
250mm	HB002504A	HB402504A	1
270mm	HB002704A	HB402704A	1
300mm	HB003004A	HB403004A	1
350mm	HB003504A	HB403504A	1
400mm	HB004004A	HB404004A	1
450mm	HB004504A	HB404504A	1
500mm	HB005004A	HB405004A	1
550mm	HB005504A	HB405504A	1
600mm	HB006004A	HB406004A	1
650mm	HB006504A	HB406504A	1

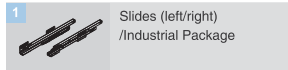

Pre-zinc Steel(F02)

NL	Soft Close Item No.	Push-open Item No.	Set/ctn
250mm	HB012504H	HB412504H	5
270mm	HB012704H	HB412704H	5
300mm	HB013004H	HB413004H	5
350mm	HB013504H	HB413504H	5
400mm	HB014004H	HB414004H	5
450mm	HB014504H	HB414504H	5
500mm	HB015004H	HB415004H	5
550mm	HB015504H	HB415504H	5
600mm	HB016004H	HB416004H	5
650mm	HB016504H	HB416504H	5

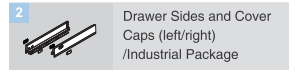

Silk White(E29) Grey Matt(E30) Stainless Steel(F04)

NL	Item No.	Set/ctn
250mm	HB00250	5
270mm	HB00270	5
300mm	HB00300	5
350mm	HB00350	5
400mm	HB00400	5
450mm	HB00450	5
500mm	HB00500	5
550mm	HB00550	5
600mm	HB00600	5
650mm	HB00650	5



Silk White(E29) Grey Matt(E30) Chrome Plated(C01)

Item No.	Set/ctn
TB00031	60

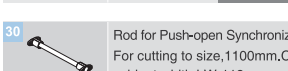

Zinc Plated(B01)

Item No.	Set/ctn
TB01011	120
TB01016	120

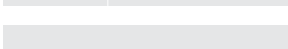

For cutting to size, 1100mm, Cutting: Internal cabinet width LW-118

Item No.	Set/ctn
HB0FH02	60

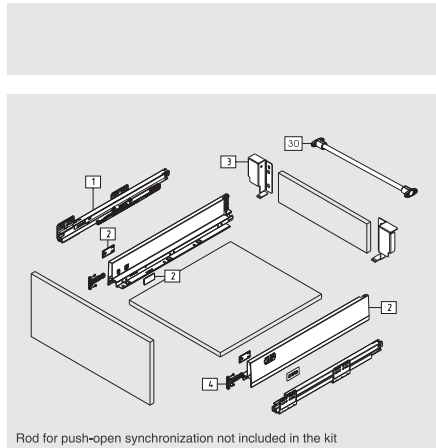

Screw Positions of the Slides(mm)

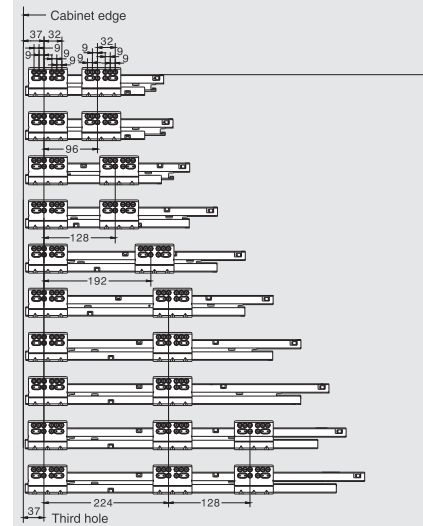

Installation Dimensions(mm)

LW=Internal Cabinet Width

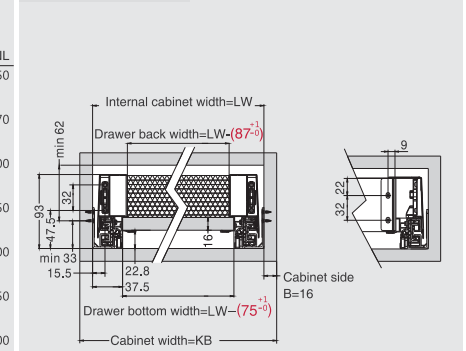

Drawer Front, Back and Bottom Dimensions(mm)

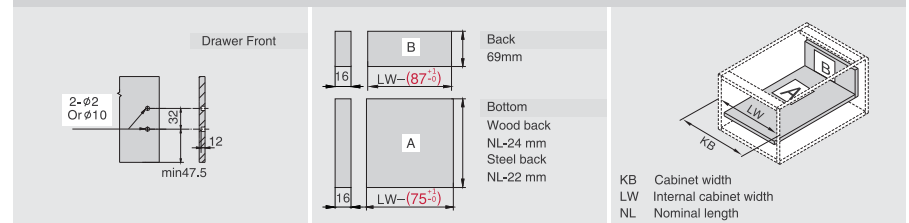

Nexus Enterprises

DRAGON-PRO

HB00 Series Straight-sided Drawer System (Low Inner Drawer: N Height)

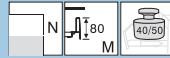

PRODUCT



DESCRIPTION

- Concealed, full extension
- Dynamic load capacity: 40/50kg
- Tool free assembly and removal of drawer
- Silent system guarantees smooth run without noise
- Up&down adjustment, left&right adjustment
- Finish: Silk white(E29), Grey matt(E30), stainless steel(F04)

SPACE REQUIREMENT

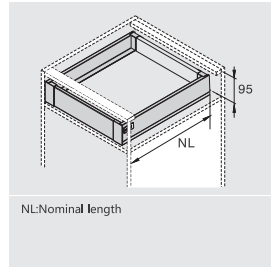

PLANNING

Installation Dimensions(mm)

NL=Nominal Slide Length
LT=Internal Cabinet Depth

Soft close drawer LT=NL+3
Push-open drawer LT=NL+12

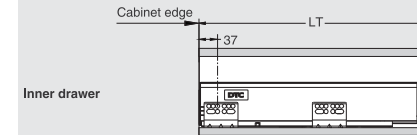

Cabinet width/KB(mm)	Soft close drawer Stabilizer	Push-open drawer Synchronization rod	
300	—	○	not recommended
350	—	○	
400	—	○	
450	—	○	
500	—	○	
600	—	○	recommended
800	○	●	
900	○	●	strongly recommended
1000	○	●	
1200	○	●	

LOWER INNER DRAWER FOR WOOD DRAWER BACK



Kit Package

Silk White(E29) | Grey Matt(E30) | Stainless Steel(F04)

NL	Soft Close Item No.	Push-open Item No.	Set/ctn
250mm	HB002504Q	HB402504Q	1
270mm	HB002704Q	HB402704Q	1
300mm	HB003004Q	HB403004Q	1
350mm	HB003504Q	HB403504Q	1
400mm	HB004004Q	HB404004Q	1
450mm	HB004504Q	HB404504Q	1
500mm	HB005004Q	HB405004Q	1
550mm	HB005504Q	HB405504Q	1
600mm	HB006004Q	HB406004Q	1
650mm	HB006504Q	HB406504Q	1



Slides (left/right) / Industrial Package

Pre-zinc Steel(F02)

NL	Soft Close Item No.	Push-open Item No.	Set/ctn
250mm	HB012504H	HB412504H	5
270mm	HB012704H	HB412704H	5
300mm	HB013004H	HB413004H	5
350mm	HB013504H	HB413504H	5
400mm	HB014004H	HB414004H	5
450mm	HB014504H	HB414504H	5
500mm	HB015004H	HB415004H	5
550mm	HB015504H	HB415504H	5
600mm	HB016004H	HB416004H	5
650mm	HB016504H	HB416504H	5

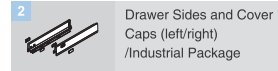

Drawer Sides and Cover Caps (left/right) / Industrial Package

Silk White(E29) | Grey Matt(E30) | Stainless Steel(F04)

NL	Item No.	Set/ctn
250mm	HB00250	5
270mm	HB00270	5
300mm	HB00300	5
350mm	HB00350	5
400mm	HB00400	5
450mm	HB00450	5
500mm	HB00500	5
550mm	HB00550	5
600mm	HB00600	5
650mm	HB00650	5



Back Fixing-brackets (left/right) / Industrial Package

Silk White(E29) | Grey Matt(E30) | Chrome Plated(C01)

Item No.	TB00031
Set/ctn	60

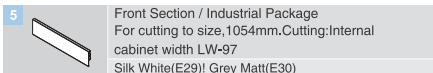

Front Fixing-brackets (left/right) / Industrial Package

White(H03) | Dark Grey(H11)

Item No.	TB00012
Set/ctn	60



Front Section / Industrial Package

For cutting to size, 1054mm. Cutting: Internal cabinet width LW-97

Silk White(E29) | Grey Matt(E30)

Item No.	TB01021
Set/ctn	20



Rod for Push-open Synchronization / Industrial Package

For cutting to size, 1100mm. Cutting: Internal cabinet width LW-118

Item No.

HB0FH02

Set/ctn

60

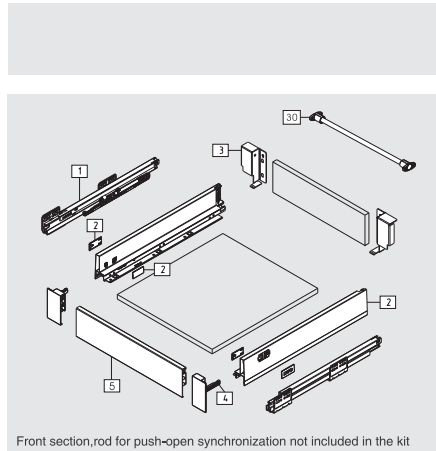

Screw Positions of the Slides(mm)

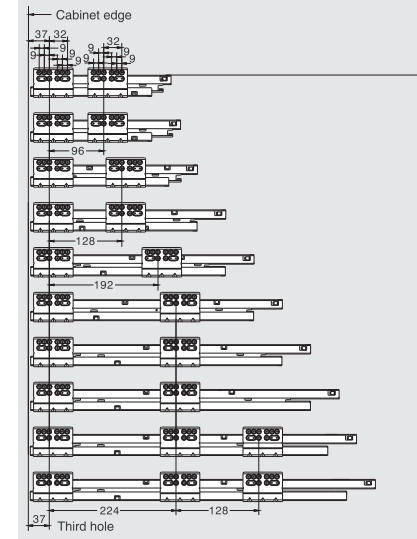

Fixing Hole Position for Push-open Inner Drawer

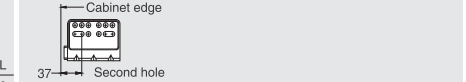

Installation Dimensions(mm)

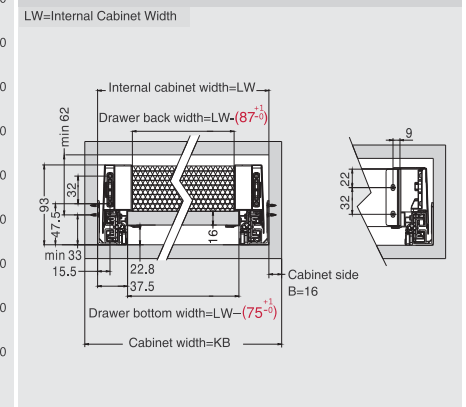

Drawer Front, Back and Bottom Dimensions(mm)

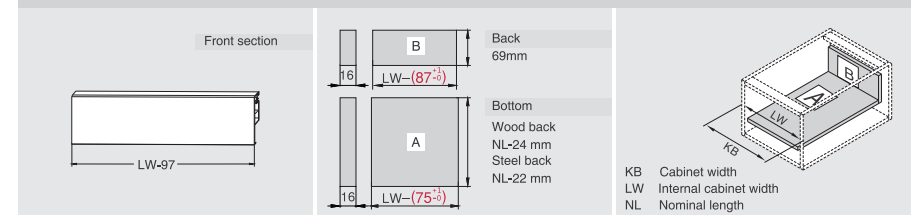

Nexus Enterprises

DRAGON-PRO

HB01 Series Straight-sided Drawer System (Medium Drawer: M Height)

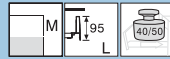

PRODUCT



DESCRIPTION

- Concealed, full extension
- Dynamic load capacity: 40/50kg
- Tool free assembly and removal of drawer
- Silent system guarantees smooth run without noise
- Up&down adjustment, left&right adjustment
- Finish: Silk white(E29), Grey matt(E30), stainless steel(F04)

SPACE REQUIREMENT

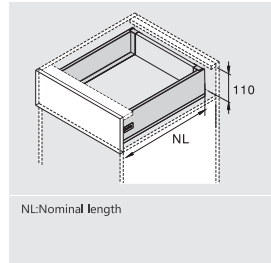

PLANNING

Installation Dimensions(mm)

NL=Nominal Slide Length
LT=Internal Cabinet Depth
LT=NL+3

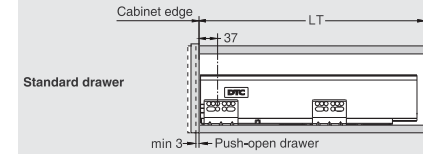

Cabinet widths KB(mm)	Soft close drawer Stabilizer	Push-open drawer Synchronization rod	
300	—	○	not recommended
350	—	○	
400	—	○	
450	—	○	
500	—	○	
600	—	○	recommended
800	○	●	
900	○	●	strongly recommended
1000	○	●	
1200	○	●	

MEDIUM DRAWER FOR WOOD DRAWER BACK

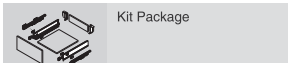

Silk White(E29) | Grey Matt(E30) | Stainless Steel(F04)

NL	Soft Close Item No.	Push-open Item No.	Set/ctn
250mm	HB012504A	HB412504A	1
270mm	HB012704A	HB412704A	1
300mm	HB013004A	HB413004A	1
350mm	HB013504A	HB413504A	1
400mm	HB014004A	HB414004A	1
450mm	HB014504A	HB414504A	1
500mm	HB015004A	HB415004A	1
550mm	HB015504A	HB415504A	1
600mm	HB016004A	HB416004A	1
650mm	HB016504A	HB416504A	1



Pre-zinc Steel(F02)

NL	Soft Close Item No.	Push-open Item No.	Set/ctn
250mm	HB012504H	HB412504H	5
270mm	HB012704H	HB412704H	5
300mm	HB013004H	HB413004H	5
350mm	HB013504H	HB413504H	5
400mm	HB014004H	HB414004H	5
450mm	HB014504H	HB414504H	5
500mm	HB015004H	HB415004H	5
550mm	HB015504H	HB415504H	5
600mm	HB016004H	HB416004H	5
650mm	HB016504H	HB416504H	5

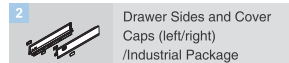

Silk White(E29) | Grey Matt(E30) | Stainless Steel(F04)

NL	Item No.	Set/ctn
250mm	HB01250	5
270mm	HB01270	5
300mm	HB01300	5
350mm	HB01350	5
400mm	HB01400	5
450mm	HB01450	5
500mm	HB01500	5
550mm	HB01550	5
600mm	HB01600	5
650mm	HB01650	5

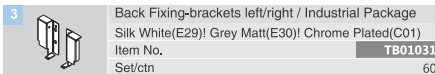

3 Back Fixing-brackets left/right / Industrial Package
Silk White(E29) | Grey Matt(E30) | Chrome Plated(C01)
Item No. **TB01031**
Set/ctn 60

4 Front Fixing-brackets left/right / Industrial Package
Zinc Plated (B01)
Item No. Set/ctn
Screw-on **TB01011** 120
Press-in **TB01016** 120

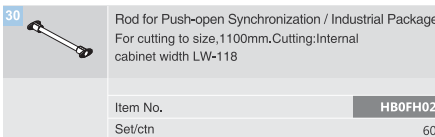

30 Rod for Push-open Synchronization / Industrial Package
For cutting to size, 1100mm. Cutting/Internal cabinet width LW-11B
Item No. **HB0FH02**
Set/ctn 60

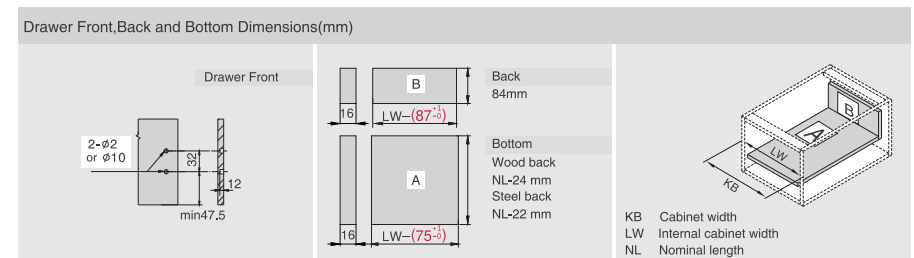
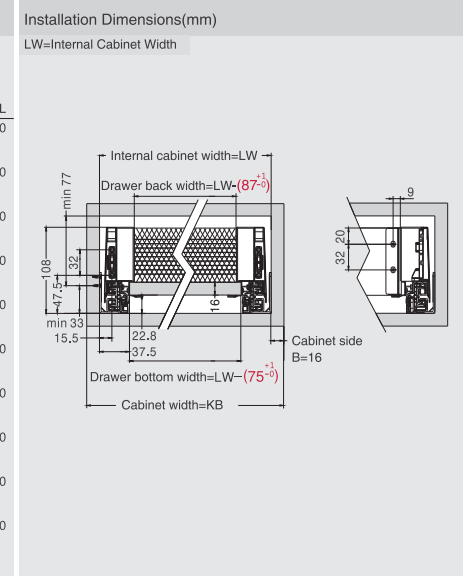
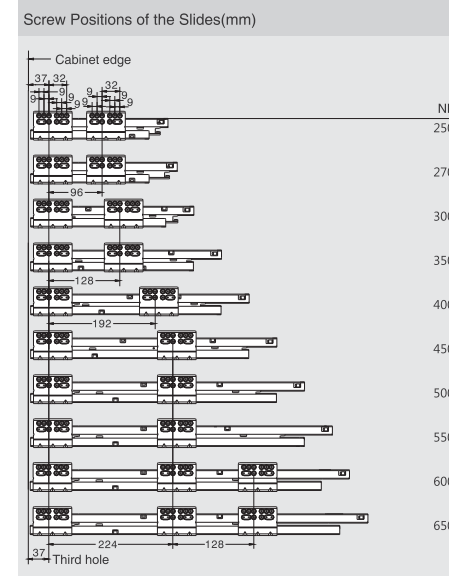
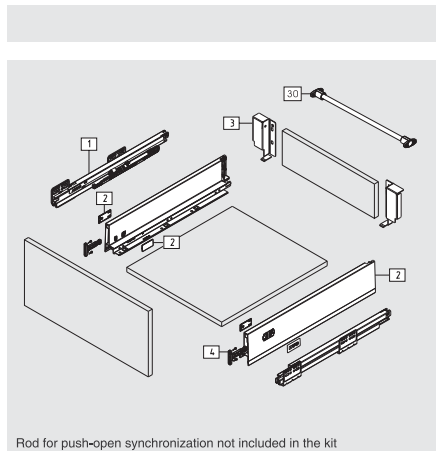

Nexus Enterprises

DRAGON-PRO

HB01 Series Straight-sided Drawer System (Medium Inner Drawer: M Height)

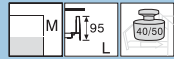

PRODUCT



DESCRIPTION

- Concealed, full extension
- Dynamic load capacity: 40/50kg
- Tool free assembly and removal of drawer
- Silent system guarantees smooth run without noise
- Up&down adjustment, left&right adjustment
- Finish: Silk white(E29), Grey matt(E30), stainless steel(F04)

SPACE REQUIREMENT

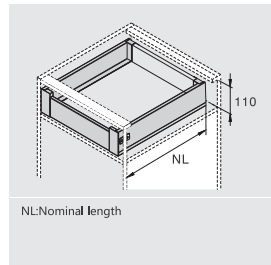

PLANNING

Installation Dimensions(mm)

NL=Nominal Slide Length Soft close drawer LT=NL+3
LT=Internal Cabinet Depth Push-open drawer LT=NL+12

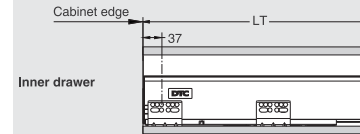

Cabinet Configuration	Cabinet width KB (mm)	Soft close drawer Stabilizer	Push-open drawer Synchronization rod	
300	300	—	○	not recommended
350	350	—	○	
400	400	—	○	
450	450	—	○	
500	500	—	○	
600	600	—	○	recommended
800	800	○	●	
900	900	○	●	strongly recommended
1000	1000	○	●	
1200	1200	○	●	

MEDIUM INNER DRAWER FOR WOOD DRAWER BACK

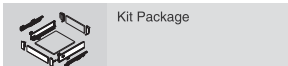

Silk White(E29) | Grey Matt(E30) | Stainless Steel(F04)

NL	Soft Close Item No.	Push-open Item No.	Set/ctn
250mm	HB012504Q	HB412504Q	1
270mm	HB012704Q	HB412704Q	1
300mm	HB013004Q	HB413004Q	1
350mm	HB013504Q	HB413504Q	1
400mm	HB014004Q	HB414004Q	1
450mm	HB014504Q	HB414504Q	1
500mm	HB015004Q	HB415004Q	1
550mm	HB015504Q	HB415504Q	1
600mm	HB016004Q	HB416004Q	1
650mm	HB016504Q	HB416504Q	1



Pre-zinc Steel(F02)

NL	Soft Close Item No.	Push-open Item No.	Set/ctn
250mm	HB012504H	HB412504H	5
270mm	HB012704H	HB412704H	5
300mm	HB013004H	HB413004H	5
350mm	HB013504H	HB413504H	5
400mm	HB014004H	HB414004H	5
450mm	HB014504H	HB414504H	5
500mm	HB015004H	HB415004H	5
550mm	HB015504H	HB415504H	5
600mm	HB016004H	HB416004H	5
650mm	HB016504H	HB416504H	5

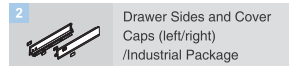

Silk White(E29) | Grey Matt(E30) | Stainless Steel(F04)

NL	Item No.	Set/ctn
250mm	HB01250	5
270mm	HB01270	5
300mm	HB01300	5
350mm	HB01350	5
400mm	HB01400	5
450mm	HB01450	5
500mm	HB01500	5
550mm	HB01550	5
600mm	HB01600	5
650mm	HB01650	5

3 Back Fixing-brackets (left/right) / Industrial Package
Silk White(E29) | Grey Matt(E30) | Chrome Plated(C01)
Item No. **TB01031**
Set/ctn 60

4 Front Fixing-brackets (left/right) / Industrial Package
White(H03) | Dark Grey(H11)
Item No. **TB01012**
Set/ctn 60

5 Front Section / Industrial Package
For cutting to size, 1054mm. Cutting: Internal cabinet width LW-97
Silk White(E29) | Grey Matt(E30)
Item No. **TB01021**
Set/ctn 20

30 Rod for Push-open Synchronization / Industrial Package
For cutting to size, 1100mm. Cutting: Internal cabinet width LW-118
Item No. **HB0FH02**
Set/ctn 60

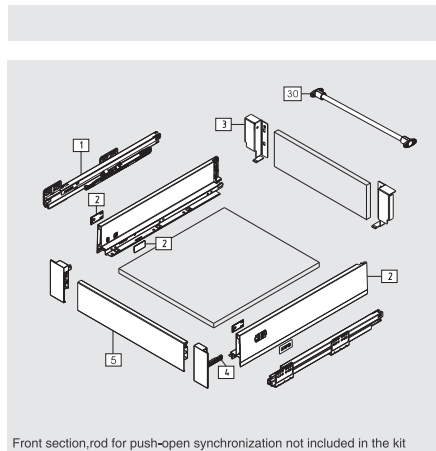

Screw Positions of the Slides(mm)

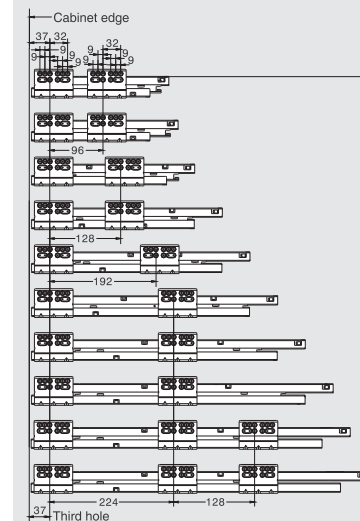

Fixing Hole Position for Push-open Inner Drawer(mm)

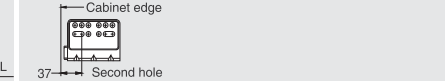

Installation Dimensions(mm)

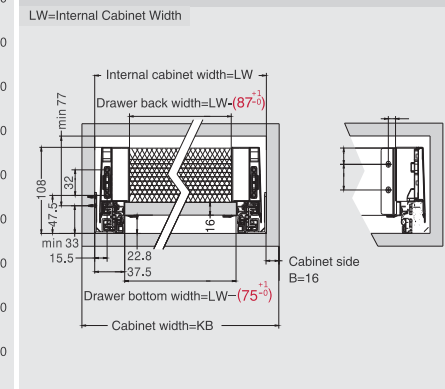

Drawer Front, Back And Bottom Dimensions(mm)

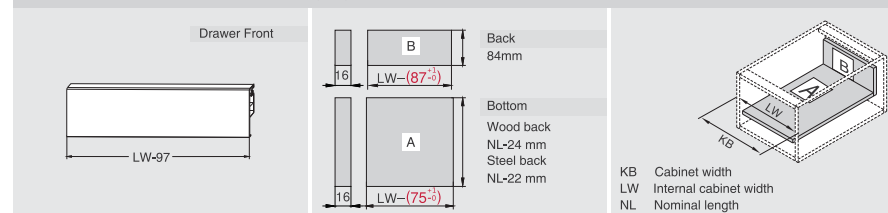

Nexus Enterprises

DRAGON-PRO

HB02 Series Straight-sided Drawer System (High Drawer: B Height)

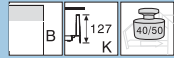

PRODUCT



DESCRIPTION

- Concealed, full extension
- Dynamic load capacity: 40/50kg
- Tool free assembly and removal of drawer
- Silent system guarantees smooth run without noise
- Up&down adjustment, left&right adjustment
- Finish: Silk white(E29), Grey matt(E30), stainless steel(F04)

SPACE REQUIREMENT

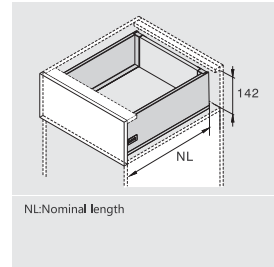

HIGH DRAWER FOR WOOD DRAWER BACK

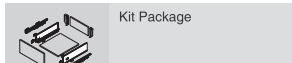

Silk White(E29) | Grey Matt(E30) | Stainless Steel(F04)

NL	Soft Close Item No.	Push-open Item No.	Set/ctn
250mm	HB022504A	HB422504A	1
270mm	HB022704A	HB422704A	1
300mm	HB023004A	HB423004A	1
350mm	HB023504A	HB423504A	1
400mm	HB024004A	HB424004A	1
450mm	HB024504A	HB424504A	1
500mm	HB025004A	HB425004A	1
550mm	HB025504A	HB425504A	1
600mm	HB026004A	HB426004A	1
650mm	HB026504A	HB426504A	1



Pre-zinc Steel(F02)

NL	Soft Close Item No.	Push-open Item No.	Set/ctn
250mm	HB012504H	HB412504H	5
270mm	HB012704H	HB412704H	5
300mm	HB013004H	HB413004H	5
350mm	HB013504H	HB413504H	5
400mm	HB014004H	HB414004H	5
450mm	HB014504H	HB414504H	5
500mm	HB015004H	HB415004H	5
550mm	HB015504H	HB415504H	5
600mm	HB016004H	HB416004H	5
650mm	HB016504H	HB416504H	5

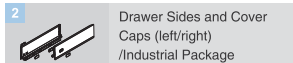

Silk White(E29) | Grey Matt(E30) | Stainless Steel(F04)

NL	Item No.	Set/ctn
250mm	HB02250	5
270mm	HB02270	5
300mm	HB02300	5
350mm	HB02350	5
400mm	HB02400	5
450mm	HB02450	5
500mm	HB02500	5
550mm	HB02550	5
600mm	HB02600	5
650mm	HB02650	5



Item No.	Set/ctn
TB02031	40

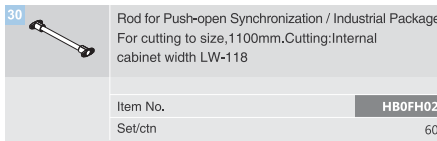

Item No.	Set/ctn
HB0FH02	60

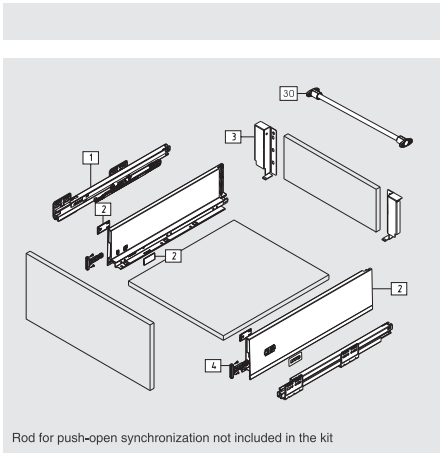

Rod for push-open synchronization not included in the kit

PLANNING

Installation Dimensions(mm)

NL=Nominal Slide Length
LT=Internal Cabinet Depth
LT=NL+3

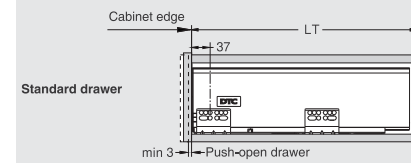

Cabinet widthKB(mm)	Soft close drawer Stabilizer	Push-open drawer Synchronization rod	
300	—	○	not recommended
350	—	○	
400	—	○	
450	—	○	
500	—	○	
600	—	○	recommended
800	○	●	
900	○	●	strongly recommended
1000	○	●	
1200	○	●	

Screw Positions of The Slides(mm)

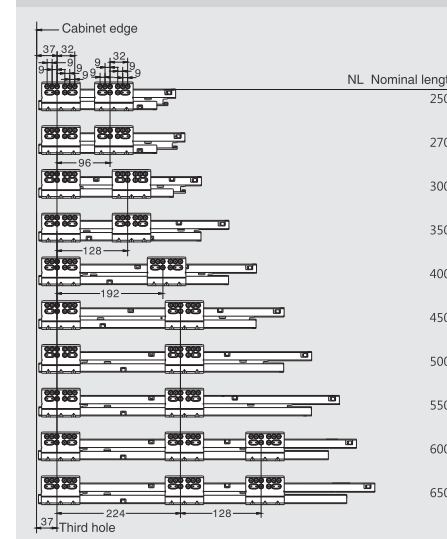

Installation Dimensions(mm)

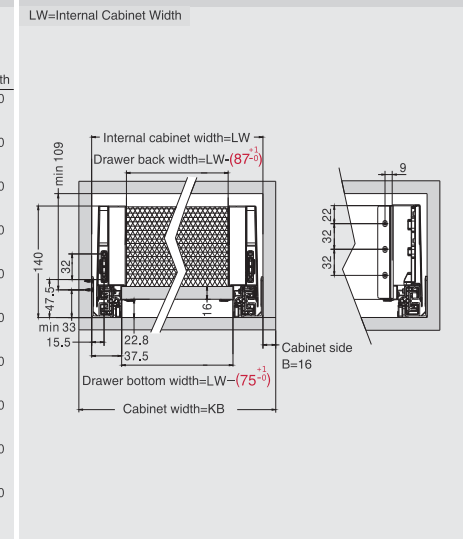

Drawer Front, Back and Bottom Dimensions(mm)

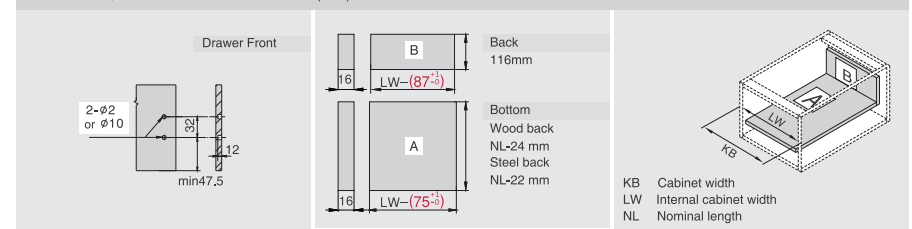

KB Cabinet width
LW Internal cabinet width
NL Nominal length

Nexus Enterprises

DRAGON-PRO

HB02 Series Straight-sided Drawer System (High Inner Drawer: B Height)

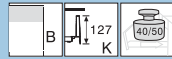

PRODUCT



DESCRIPTION

- Concealed, full extension
- Dynamic load capacity: 40/50kg
- Tool free assembly and removal of drawer
- Silent system guarantees smooth run without noise
- Up&down adjustment, left&right adjustment
- Finish: Silk white(E29), Grey matt(E30), stainless steel(F04)

SPACE REQUIREMENT

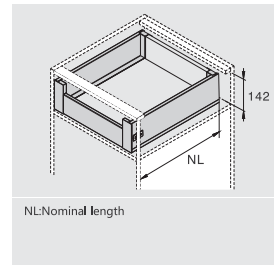

HIGH DRAWER FOR WOOD DRAWER BACK

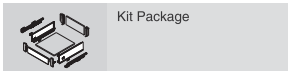

Silk White(E29) Grey Matt(E30) Stainless Steel(F04)

NL	Soft Close slide item No.	Push-open item No.	Set/ctn
250mm	HB022504Q	HB422504Q	1
270mm	HB022704Q	HB422704Q	1
300mm	HB023004Q	HB423004Q	1
350mm	HB023504Q	HB423504Q	1
400mm	HB024004Q	HB424004Q	1
450mm	HB024504Q	HB424504Q	1
500mm	HB025004Q	HB425004Q	1
550mm	HB025504Q	HB425504Q	1
600mm	HB026004Q	HB426004Q	1
650mm	HB026504Q	HB426504Q	1

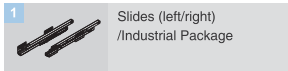

Pre-zinc Steel(F02)

NL	Soft Close slide item No.	Push-open item No.	Set/ctn
250mm	HB012504H	HB412504H	5
270mm	HB012704H	HB412704H	5
300mm	HB013004H	HB413004H	5
350mm	HB013504H	HB413504H	5
400mm	HB014004H	HB414004H	5
450mm	HB014504H	HB414504H	5
500mm	HB015004H	HB415004H	5
550mm	HB015504H	HB415504H	5
600mm	HB016004H	HB416004H	5
650mm	HB016504H	HB416504H	5

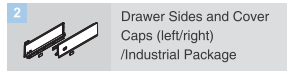

Silk White(E29) Grey Matt(E30) Stainless Steel(F04)

NL	Item No.	Set/ctn
250mm	HB02250	5
270mm	HB02270	5
300mm	HB02300	5
350mm	HB02350	5
400mm	HB02400	5
450mm	HB02450	5
500mm	HB02500	5
550mm	HB02550	5
600mm	HB02600	5
650mm	HB02650	5



Back Fixing-brackets (left/right) / Industrial Package
Silk White(E29) Grey Matt(E30) Chrome Plated(C01)
Item No. TB02031
Set/ctn 40

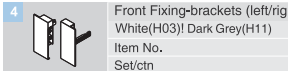

Front Fixing-brackets (left/right) / Industrial Package
White(H03) Dark Grey(H11)
Item No. TB02012
Set/ctn 40

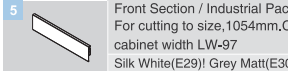

Front Section / Industrial Package
For cutting to size,1054mm.Cutting:Internal cabinet width LW-97
Silk White(E29) Grey Matt(E30)
Item No. TB01021
Set/ctn 20

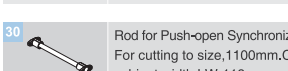

Rod for Push-open Synchronization / Industrial Package
For cutting to size,1100mm.Cutting:Internal cabinet width LW-118
Item No. HB0FH02
Set/ctn 60

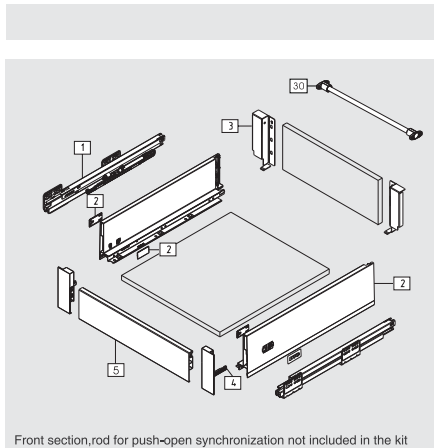

Front section,rod for push-open synchronization not included in the kit

PLANNING

Installation Dimensions(mm)

NL=Nominal Slide Length Soft close drawer LT=NL+3
LT=Internal Cabinet Depth Push-open drawer LT=NL+12

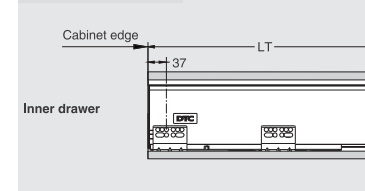

Cabinet Configuration

Cabinet width/KB(mm)	Soft close drawer Stabilizer	Push-open drawer Synchronization rod	
300	—	○	not recommended
350	—	○	
400	—	○	
450	—	○	
500	—	○	
600	—	○	recommended
800	○	●	
900	○	●	strongly recommended
1000	○	●	
1200	○	●	

Screw Positions of the Slides(mm)

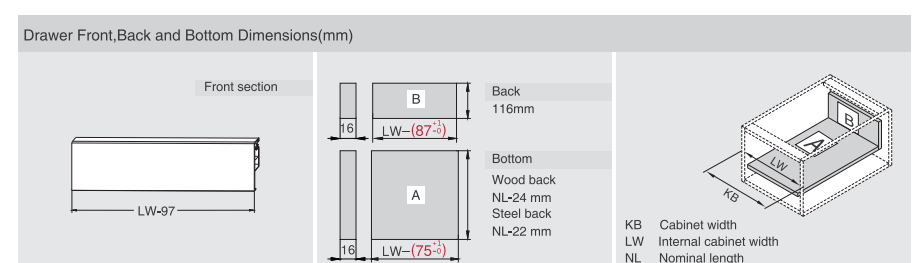
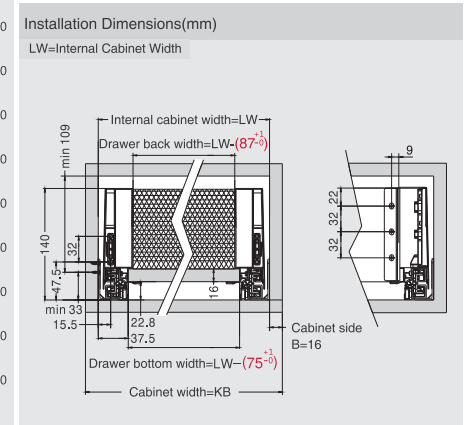
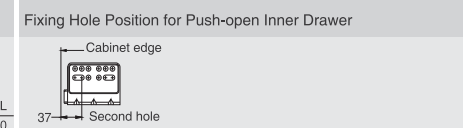
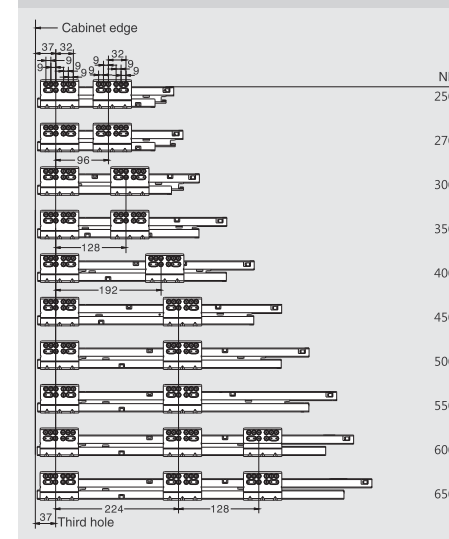

DRAGON-PRO

HB03 Series Straight-sided Drawer System (Extra High Drawer: D Height)



PRODUCT



DESCRIPTION

- Concealed, full extension
- Dynamic load capacity: 40/50kg
- Tool free assembly and removal of drawer
- Silent system guarantees smooth run without noise
- Up&down adjustment, left&right adjustment
- Finish: Silk white(E29), Grey matt(E30), stainless steel(F04)

SPACE REQUIREMENT

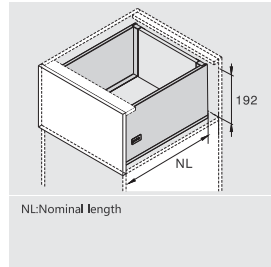

PLANNING

Installation Dimensions(mm)

NL=Nominal Slide Length
LT=Internal Cabinet Depth
LT=NL+3

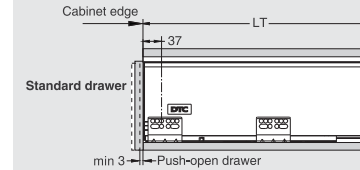

Cabinet Configuration

Cabinet width KB (mm)	Soft close drawer Stabilizer	Push-open drawer Synchronization rod	
300	—	○	not recommended
350	—	○	
400	—	○	
450	—	○	
500	—	○	recommended
600	—	○	
800	○	●	strongly recommended
900	○	●	
1000	○	●	
1200	○	●	

EXTRA HIGH DRAWER FOR WOOD DRAWER BACK

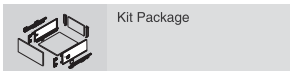

Kit Package

Silk White(E29) Grey Matt(E30) Stainless Steel(F04)

NL Soft Close Item No. Push-open Item No. Set/ctn

250mm HB032504A HB432504A 1

270mm HB032704A HB432704A 1

300mm HB033004A HB433004A 1

350mm HB033504A HB433504A 1

400mm HB034004A HB434004A 1

450mm HB034504A HB434504A 1

500mm HB035004A HB435004A 1

550mm HB035504A HB435504A 1

600mm HB036004A HB436004A 1

650mm HB036504A HB436504A 1

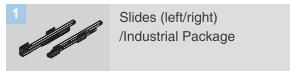

Slides (left/right) / Industrial Package

Pre-zinc Steel(F02)

NL Soft Close Item No. Push-open Item No. Set/ctn

250mm HB012504H HB412504H 5

270mm HB012704H HB412704H 5

300mm HB013004H HB413004H 5

350mm HB013504H HB413504H 5

400mm HB014004H HB414004H 5

450mm HB014504H HB414504H 5

500mm HB015004H HB415004H 5

550mm HB015504H HB415504H 5

600mm HB016004H HB416004H 5

650mm HB016504H HB416504H 5

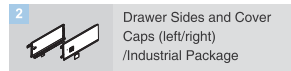

Drawer Sides and Cover Caps (left/right) / Industrial Package

Silk White(E29) Grey Matt(E30) Stainless Steel(F04)

NL Item No. Set/ctn

250mm HB03250 5

270mm HB03270 5

300mm HB03300 5

350mm HB03350 5

400mm HB03400 5

450mm HB03450 5

500mm HB03500 5

550mm HB03550 5

600mm HB03600 5

650mm HB03650 5

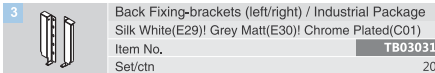

Back Fixing-brackets (left/right) / Industrial Package

Silk White(E29) Grey Matt(E30) Chrome Plated(C01)

Item No. TB03031 Set/ctn 20

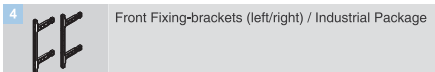

Front Fixing-brackets (left/right) / Industrial Package

Zinc Plated (B01)

Item No. Set/ctn

Screw-on TB03011 60

Press-in TB03016 60

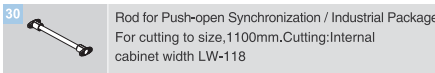

Rod for Push-open Synchronization / Industrial Package

For cutting to size, 1100mm. Cutting: Internal cabinet width LW-118

Item No. HB0FH02 Set/ctn 60

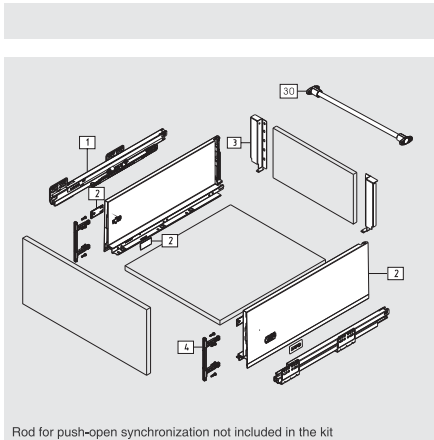

Screw Positions of the Slides(mm)

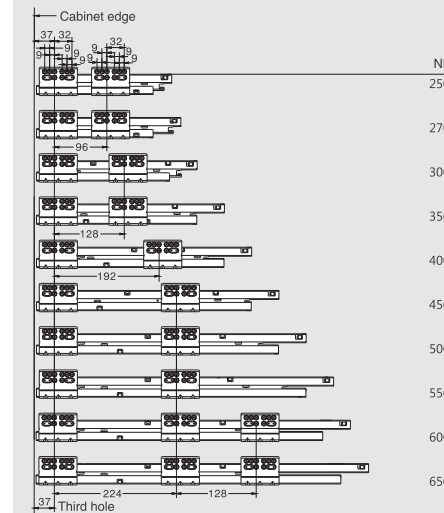

Installation Dimensions(mm)

LW=Internal Cabinet Width

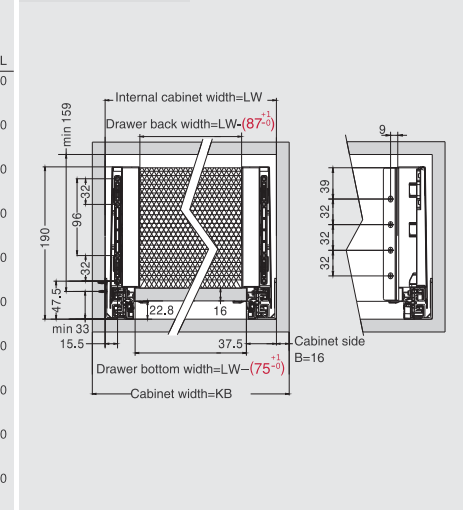

Front Section, Back and Bottom Dimensions(mm)

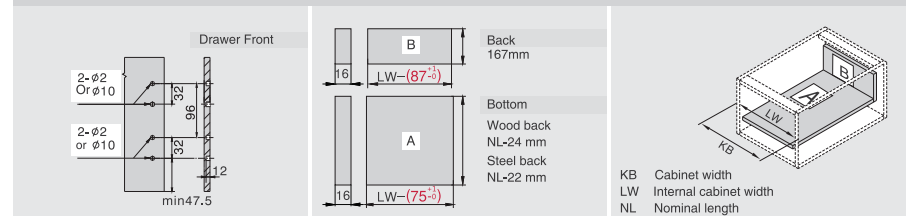

DRAGON-PRO

HB03 Series Straight-sided Drawer System (Extra High Inner Drawer: D Height)



PRODUCT



DESCRIPTION

- Concealed, full extension
- Dynamic load capacity: 40/50kg
- Tool free assembly and removal of drawer
- Silent system guarantees smooth run without noise
- Up&down adjustment, left&right adjustment
- Finish: Silk white(E29), Grey matt(E30), stainless steel(F04)

SPACE REQUIREMENT

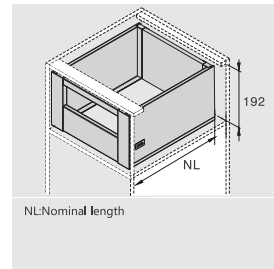

PLANNING

Installation Dimensions(mm)

NL=Nominal Slide Length Soft close drawer LT=NL+3
 LT=Internal Cabinet Depth Push-open drawer LT=NL+12

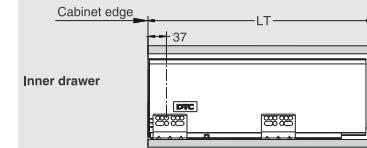

Cabinet Configuration

Cabinet width/KB(mm)	Soft close drawer Stabilizer	Push-open drawer Synchronization rod	
300	—	○	not recommended
350	—	○	
400	—	○	
450	—	○	
500	—	○	
600	—	○	recommended
800	○	●	
900	○	●	strongly recommended
1000	○	●	
1200	○	●	

EXTRA HIGH INNER DRAWER FOR WOOD DRAWER BACK

Kit Package				1 Slides (left/right) / Industrial Package				2 Drawer Sides and Cover Caps (left/right) / Industrial Package			
Silk White(E29) Grey Matt(E30) Stainless Steel(F04)				Pre-zinc Steel(F02)				Silk White(E29) Grey Matt(E30) Stainless Steel(F04)			
NL	Soft Close Item No.	Push-open Item No.	Set/ctn	NL	Soft Close Item No.	Push-open Item No.	Set/ctn	NL	Item No.	Set/ctn	Set/ctn
250mm	HB032504Q	HB432504Q	1	250mm	HB012504H	HB412504H	5	250mm	HB03250	5	5
270mm	HB032704Q	HB432704Q	1	270mm	HB012704H	HB412704H	5	270mm	HB03270	5	5
300mm	HB033004Q	HB433004Q	1	300mm	HB013004H	HB413004H	5	300mm	HB03300	5	5
350mm	HB033504Q	HB433504Q	1	350mm	HB013504H	HB413504H	5	350mm	HB03350	5	5
400mm	HB034004Q	HB434004Q	1	400mm	HB014004H	HB414004H	5	400mm	HB03400	5	5
450mm	HB034504Q	HB434504Q	1	450mm	HB014504H	HB414504H	5	450mm	HB03450	5	5
500mm	HB035004Q	HB435004Q	1	500mm	HB015004H	HB415004H	5	500mm	HB03500	5	5
550mm	HB035504Q	HB435504Q	1	550mm	HB015504H	HB415504H	5	550mm	HB03550	5	5
600mm	HB036004Q	HB436004Q	1	600mm	HB016004H	HB416004H	5	600mm	HB03600	5	5
650mm	HB036504Q	HB436504Q	1	650mm	HB016504H	HB416504H	5	650mm	HB03650	5	5

3	Back Fixing-brackets (left/right) / Industrial Package Silk White(E29) Grey Matt(E30) Chrome Plated(C01) Item No. TB03031 Set/ctn 20
4	Back Fixing-brackets (left/right) / Industrial Package White(H03) Dark Grey(H11) Item No. TB03012 Set/ctn 20
5	Front Section / Industrial Package For cutting to size,1054mm.Cutting:Internal cabinet width LW-97 Silk White(E29) Item No. TB01021 Grey Matt(E30) Pcs/ctn 20
7	Cross Square Rail / Industrial Package For cutting to size,1100mm.Cutting:Internal cabinet width LW-74 Silk White(E29) Item No. M01078 Grey Matt(E30) Pcs/ctn 60
30	Rod for Push-open Synchronization/ Industrial Package For cutting to size,1100mm.Cutting:Internal cabinet width LW-118 Item No. HB0FH02 Set/ctn 60

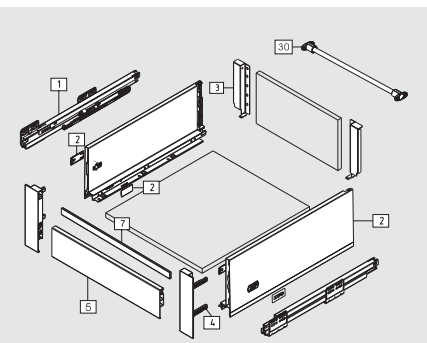

Front section,cross rail and rod for push-open synchronization not included in the kit

Screw Positions of the Slides(mm)



Fixing Hole Position for Push-open Inner Drawer

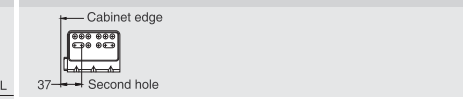

Installation Dimensions(mm)

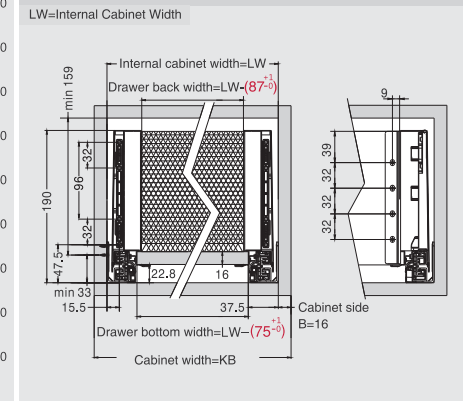

Front Section, Back and Bottom Dimensions(mm)

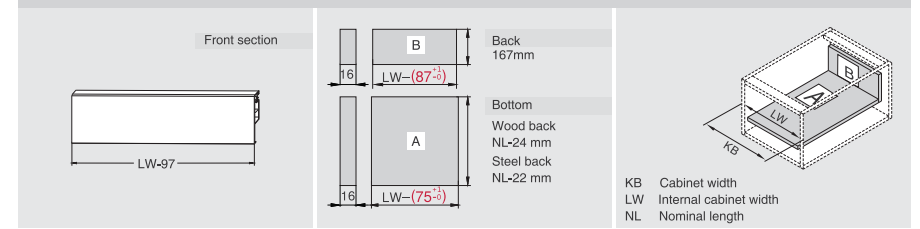

DRAGON-PRO

HB03 Series Straight-sided Drawer System (Extra High Inner Drawer: D Height)



PRODUCT



DESCRIPTION

- Concealed, full extension
- Dynamic load capacity: 40/50kg
- Tool free assembly and removal of drawer
- Silent system guarantees smooth run without noise
- Up&down adjustment, left&right adjustment
- Finish: Silk white(E29), Grey matt(E30), stainless steel(F04)

SPACE REQUIREMENT

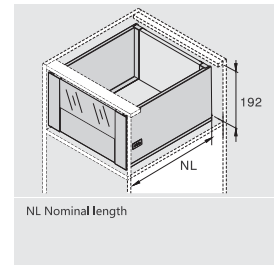

PLANNING

Installation Dimensions(mm)

NL=Nominal Slide Length Soft close drawer LT=NL+3
LT=Internal Cabinet Depth Push-open drawer LT=NL+12

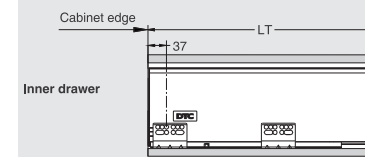

Cabinet Configuration

Cabinet width/KB(mm)	Soft close drawer Stabilizer	Push-open drawer Synchronization rod	
300	—	○	not recommended
350	—	○	
400	—	○	
450	—	○	
500	—	○	
600	—	○	recommended
800	○	●	
900	○	●	strongly recommended
1000	○	●	
1200	○	●	

EXTRA HIGH INNER DRAWER FOR WOOD DRAWER BACK



Silk White(E29) Grey Matt(E30) Stainless Steel(F04)

NL	Soft Close Item No.	Push-open Item No.	Set/ctn
250mm	HB032504Q1	HB432504Q1	1
270mm	HB032704Q1	HB432704Q1	1
300mm	HB033004Q1	HB433004Q1	1
350mm	HB033504Q1	HB433504Q1	1
400mm	HB034004Q1	HB434004Q1	1
450mm	HB034504Q1	HB434504Q1	1
500mm	HB035004Q1	HB435004Q1	1
550mm	HB035504Q1	HB435504Q1	1
600mm	HB036004Q1	HB436004Q1	1
650mm	HB036504Q1	HB436504Q1	1



Pre-zinc Steel(F02)

NL	Soft Close Item No.	Push-open Item No.	Set/ctn
250mm	HB012504H	HB412504H	5
270mm	HB012704H	HB412704H	5
300mm	HB013004H	HB413004H	5
350mm	HB013504H	HB413504H	5
400mm	HB014004H	HB414004H	5
450mm	HB014504H	HB414504H	5
500mm	HB015004H	HB415004H	5
550mm	HB015504H	HB415504H	5
600mm	HB016004H	HB416004H	5
650mm	HB016504H	HB416504H	5

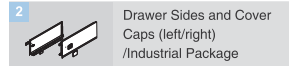

Silk White(E29) Grey Matt(E30) Stainless Steel(F04)

NL	Item No.	Set/ctn
250mm	HB03250	5
270mm	HB03270	5
300mm	HB03300	5
350mm	HB03350	5
400mm	HB03400	5
450mm	HB03450	5
500mm	HB03500	5
550mm	HB03550	5
600mm	HB03600	5
650mm	HB03650	5



Glass(G01) Ground Glass(G02) Figured Glass(G03)

KB	Item No.	Pcs/ctn
300mm	TB01061300	20
350mm	TB01061350	20
400mm	TB01061400	20
450mm	TB01061450	20
500mm	TB01061500	20
550mm	TB01061550	20
600mm	TB01061600	20



Silk White(E29) Grey Matt(E30)

Item No.	Pcs/ctn
TB01021	20



Item No. HB0FH02

Set/ctn
60



Silk White(E29) Grey Matt(E30) Chrome Plated(C01)

Item No.	Set/ctn
TB03031	20

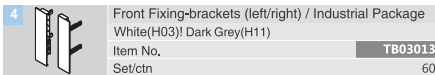

White(H03) Dark Grey(H11)

Item No.	Set/ctn
TB03013	60

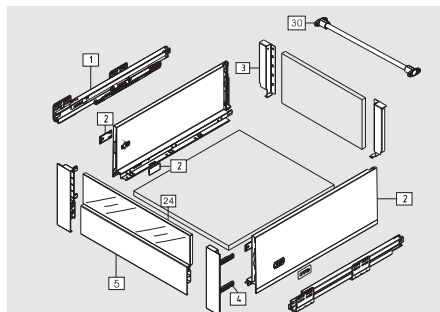

Front Section, Glass front and Rod for Push-open Synchronization not included in the Kit

Screw Positions of the Slides(mm)

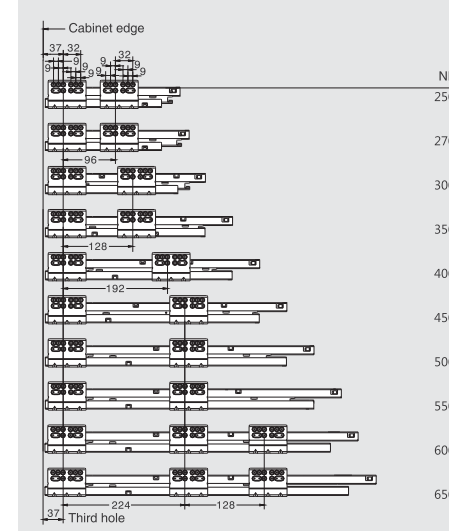

Fixing Hole Position for Push-open Inner Drawer

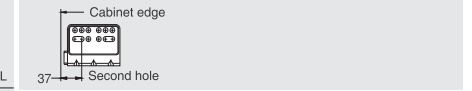

Installation Dimensions(mm)

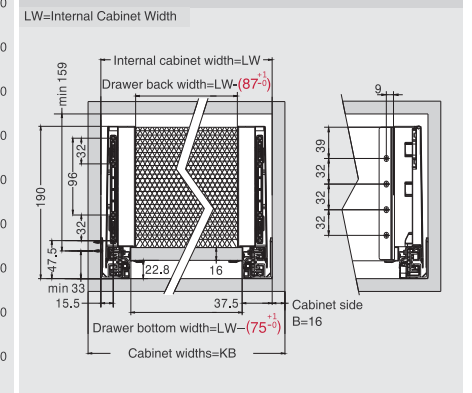

Glass Front, Back and Bottom Dimensions(mm)

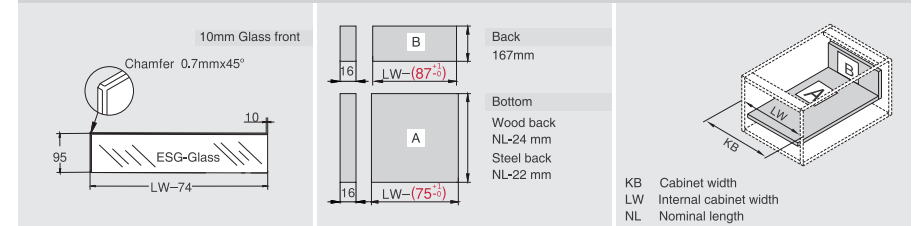

KB Cabinet width
LW Internal cabinet width
NL Nominal length

DRAGON-PRO

HB Series DRAGON-PRO



PRODUCT



DESCRIPTION

- Concealed, full extension
- Dynamic load capacity: 40/50kg
- Tool free assembly and removal of drawer
- Silent system guarantees smooth run without noise
- Up&down adjustment, left&right adjustment
- Finish: Silk white(E29), Grey matt(E30), stainless steel(F04)

SPACE REQUIREMENT

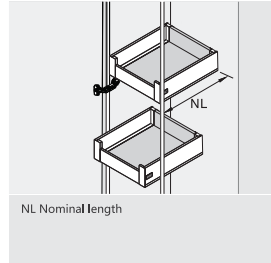

DRAWER FOR LARDER UNIT

Inner drawer recommendation	
See page	178 182 186
Door hinge recommendation	
Snap-on Soft close Hinge 155°Cam-adjustable)	44

Space requirement in cabinet

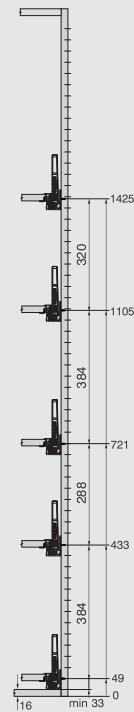

Cabinet drilling dimensions

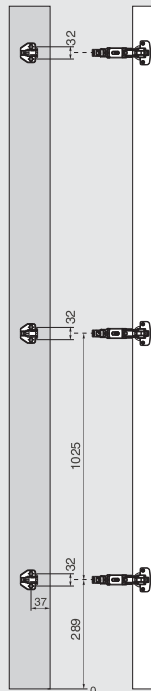

All dimensions are aligned with the 32mm system.
1st system drilling based on cabinet base 16mm and bottom gap=0mm.

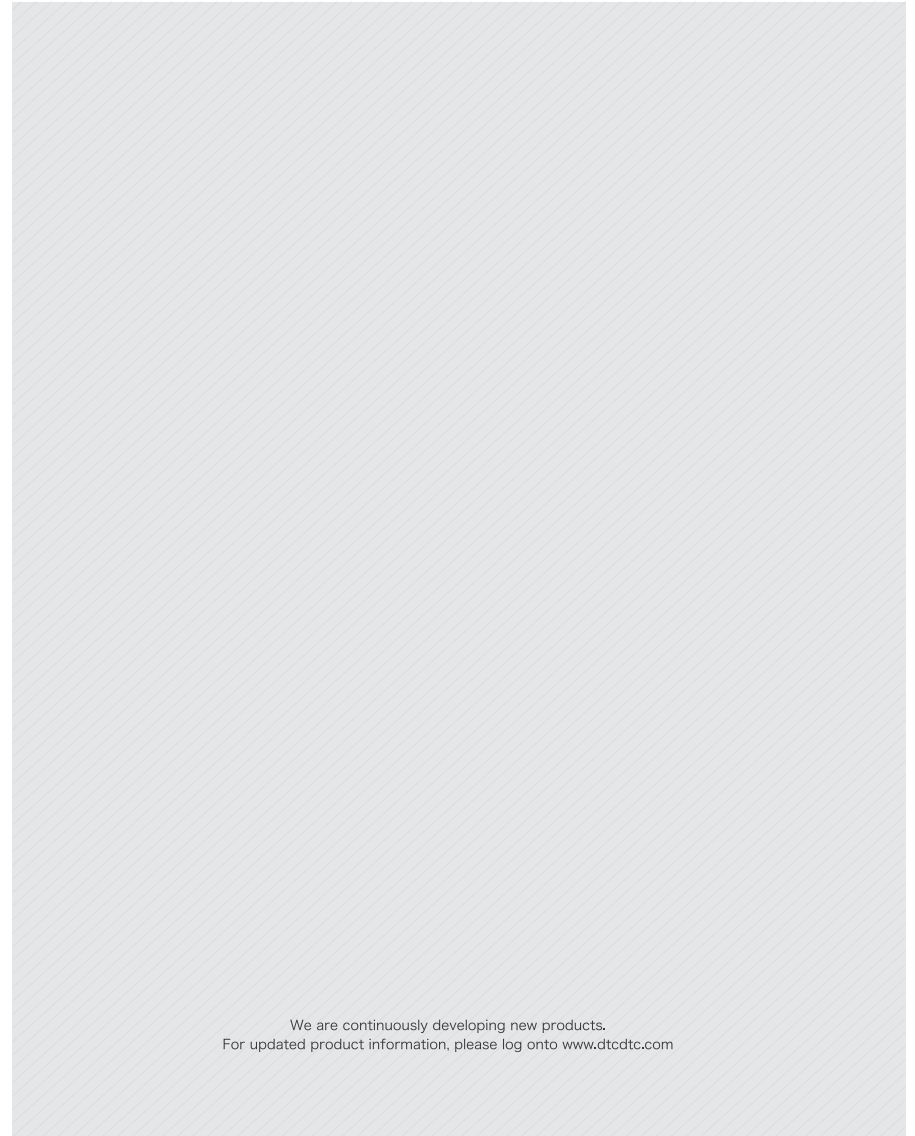

We are continuously developing new products.
For updated product information, please log onto www.dtcctc.com

ASSEMBLY AND ADJUSTMENT

Assembly and Adjustment(for DRAGON-PRO)

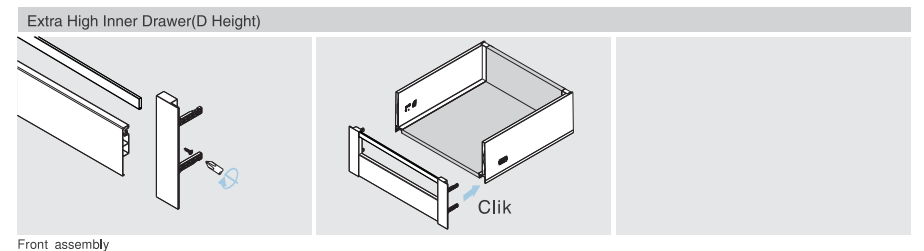
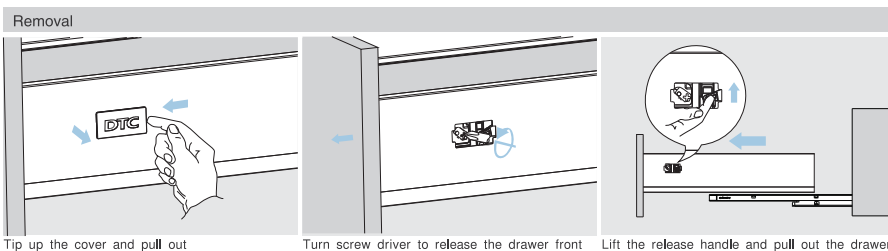
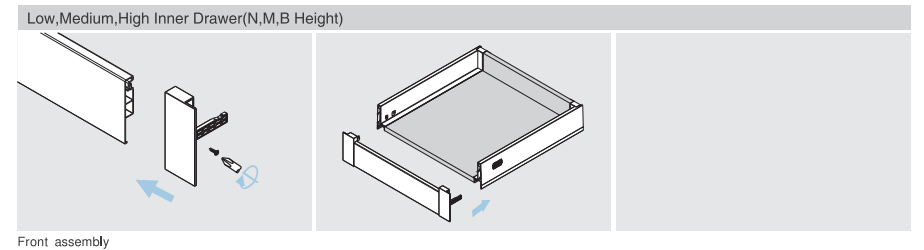
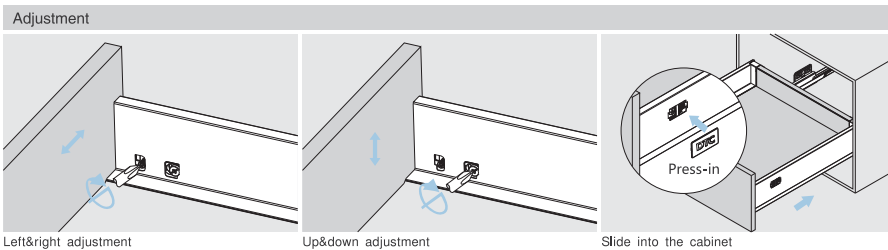
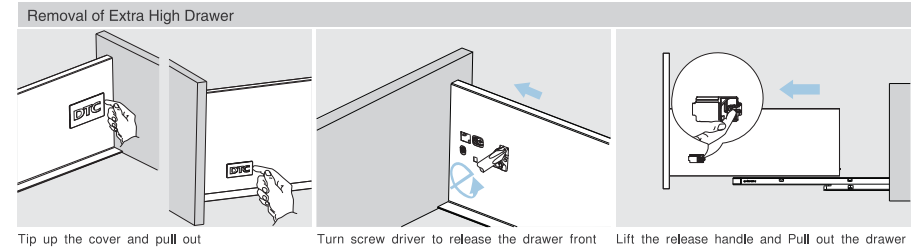
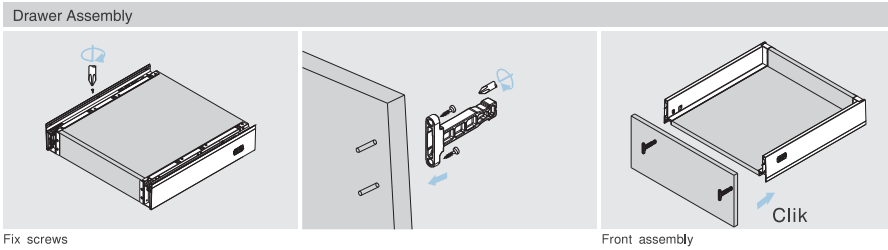
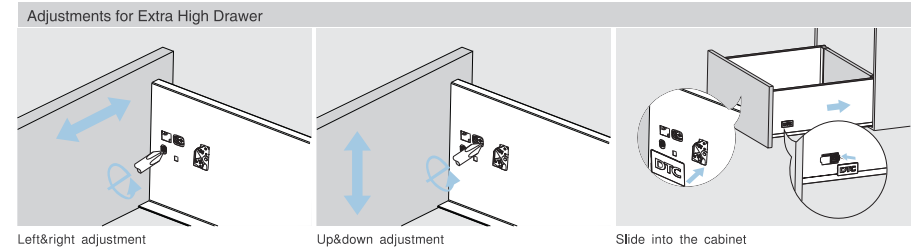
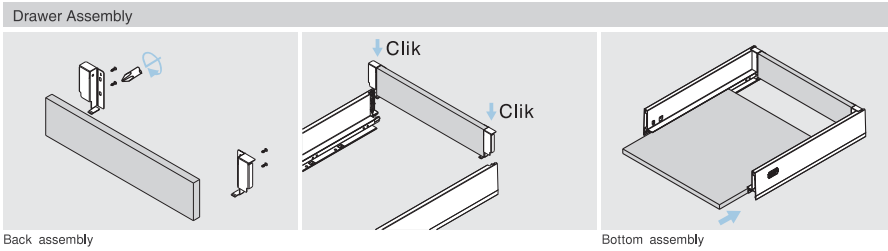

METAL DRAWER BACKS

Metal Drawer Backs(for DRAGON-PRO)



ORDER INFORMATION

Metal Drawer back Low Drawer(N Height)		
Cabinet width(mm)	Item No.	Pcs/ctn
300	TB0034300	20
325	TB0034325	20
350	TB0034350	20
375	TB0034375	20
400	TB0034400	20
450	TB0034450	20
500	TB0034500	20
600	TB0034600	20
700	TB0034700	20
800	TB0034800	20
900	TB0034900	20
1000	TB00341000	20
1200	TB00341200	20

Metal Drawer back Medium Drawer(M Height)		
Cabinet width(mm)	Item No.	Pcs/ctn
300	TB0134300	20
325	TB0134325	20
350	TB0134350	20
375	TB0134375	20
400	TB0134400	20
450	TB0134450	20
500	TB0134500	20
600	TB0134600	20
700	TB0134700	20
800	TB0134800	20
900	TB0134900	20
1000	TB01341000	20
1200	TB01341200	20

Metal Drawer back High Drawer(B Height)		
Cabinet width(mm)	Item No.	Pcs/ctn
300	TB0234300	20
325	TB0234325	20
350	TB0234350	20
375	TB0234375	20
400	TB0234400	20
450	TB0234450	20
500	TB0234500	20
600	TB0234600	20
700	TB0234700	20
800	TB0234800	20
900	TB0234900	20
1000	TB02341000	20
1200	TB02341200	20

Metal Drawer back Extra High Drawer(D Height)		
Cabinet width(mm)	Item No.	Pcs/ctn
300	TB0334300	20
325	TB0334325	20
350	TB0334350	20
375	TB0334375	20
400	TB0334400	20
450	TB0334450	20
500	TB0334500	20
600	TB0334600	20
700	TB0334700	20
800	TB0334800	20
900	TB0334900	20
1000	TB03341000	20
1200	TB03341200	20

Calculation of Width

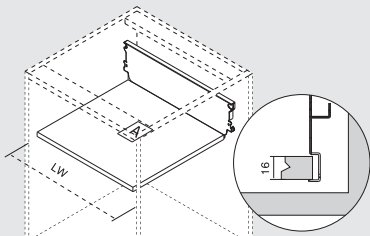

Cabinet side thickness: B=16mm. For different cabinet side thickness e.g 18mm or 19mm, customised metal back is needed.

Cutting Dimensions for 16mm Chipboard

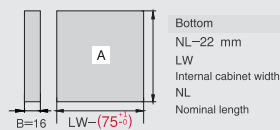

STABILIZER

SIDE Stabilizer(for DRAGON-PRO)

ORDER INFORMATION

Installation Dimensions for Side Stabilizer			
Nominal Length	Item No.	set/ctn	
450 mm	M01081450	60	<p>A Stabilizer Rod: Length=Internal Cabinet width LW-9</p> <p>Stabilizer for high and wide drawer applicable for cabinet widths KB 800-1200mm</p>
500 mm	M01081500	60	
550 mm	M01081550	60	
600 mm	M01081600	60	
650 mm	M01081650	60	

NL=Nominal length LT=Internal Cabinet Depth LT=NL+29

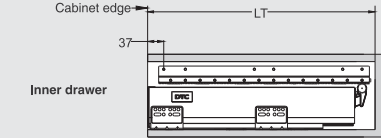
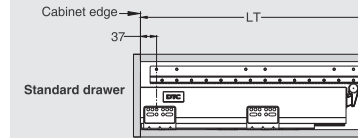

Installation Dimensions(mm)

Low Drawer

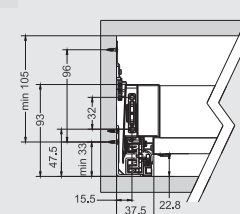

Medium Drawer

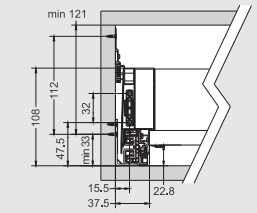

High Drawer

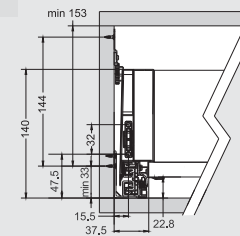

Extra High Drawer

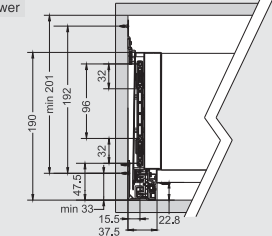

Installation

